

VC-R30

HD Camera

(PTZ Video Camera)

User Manual - English

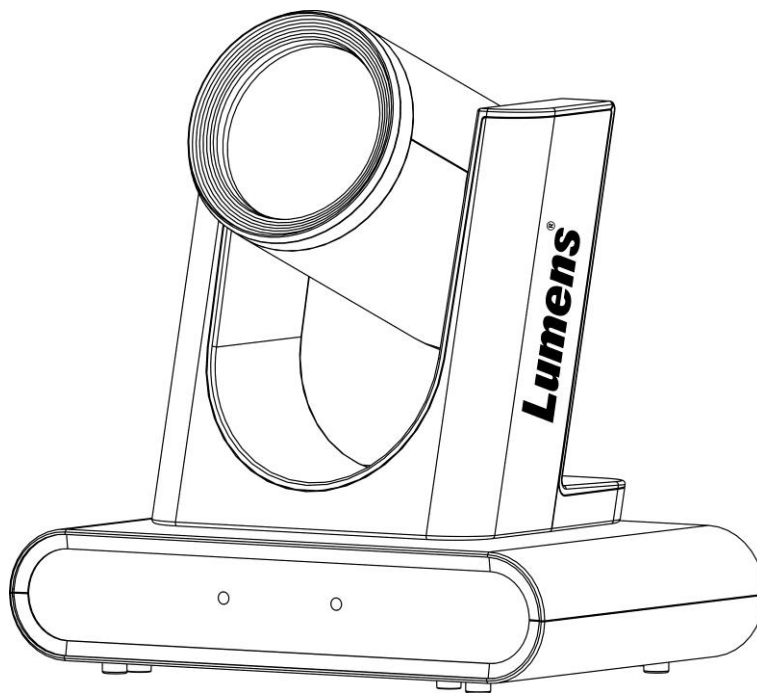

Version VXF100

[Important]

To download the latest version of Quick Start Guide, multilingual user manual, software, or driver, etc., please visit Lumens
<https://www.MyLumens.com/support>

Table of Contents

Chapter 1 Package Contents	2
Chapter 2 Version Description	3
Chapter 3 Product Overview and Interface	4
3.1 I/O functions Introduction	4
3.2 Description of LED indicator	5
Chapter 4 Instruction for installation	6
4.1 Preparation before installation.....	6
4.2 Instruction for installation	6
4.3 Connecting devices.....	8
Chapter 5 Introduction of Remote Control and Setting Menu	10
5.1 Remote Control.....	10
5.2 Setting Menu	11
Chapter 6 Network Function Settings Description	14
6.1 Web System Requirements	14
6.2 Connecting Camera to Network	14
6.3 Web Page Menu Function Description	16
Chapter 7 Troubleshooting	26
Chapter 8 Safety Instructions	27
Supplier's Declaration of Conformity 47 CFR § 2.1077 Compliance Information	28
Copyright Information	29

Chapter 1 Package Contents

VC-R30

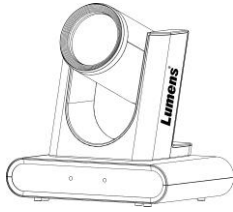

**Quick Installation
Guide**



Remote Control

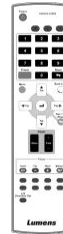

Power Cord

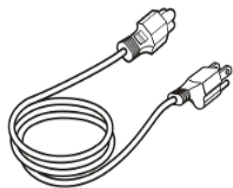

**Appearance may vary
depending on country/
region**

Power Adapter

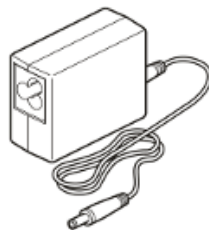

**3-PIN to 2-PIN
connector**



(For Japan only)

**USB 3.0 Cable
(2m)**



**HDMI cable
(1.5m)**



Chapter 2 Version Description

This chapter specifies the identification method of VC-R30 and VC-R30,V1. Some functions may vary due to different versions.

Model		VC-R30	VC-R30,V1
Label		<p>Model: VC-R30 PTZ Video Camera</p> <p>DC INPUT : DC12V \pm 2.5A (MAX)</p> <p>THIS DEVICE COMPLIES WITH PART 15 OF THE FCC RULES. OPERATION IS SUBJECT TO THE FOLLOWING TWO CONDITIONS: (1) THIS DEVICE MAY NOT CAUSE HARMFUL INTERFERENCE, AND (2) THIS DEVICE MUST ACCEPT ANY INTERFERENCE RECEIVED, INCLUDING INTERFERENCE THAT MAY CAUSE UNDESIRABLE OPERATION.</p> <p>IS 618:2017 / IEC 60065:2014</p> <p>Lumens Lumens Digital Optics Inc. www.MyLumens.com</p> <p>R-41182959 www.bis.gov.in</p> <p>Made in Taiwan</p>	<p>Model: VC-R30 PTZ Video Camera</p> <p>DC INPUT : DC12V \pm 2.5A (MAX)</p> <p>THIS DEVICE COMPLIES WITH PART 15 OF THE FCC RULES. OPERATION IS SUBJECT TO THE FOLLOWING TWO CONDITIONS: (1) THIS DEVICE MAY NOT CAUSE HARMFUL INTERFERENCE, AND (2) THIS DEVICE MUST ACCEPT ANY INTERFERENCE RECEIVED, INCLUDING INTERFERENCE THAT MAY CAUSE UNDESIRABLE OPERATION.</p> <p>IS 618:2017 / IEC 60065:2014</p> <p>Lumens Lumens Digital Optics Inc. www.MyLumens.com</p> <p>R-41182959 www.bis.gov.in</p> <p>Made in Taiwan</p>
SN	Black	VC1xxxxxx	VD4xxxxxx
	White	VCYxxxxxx	VD7xxxxxx
FW		VWWxxx	VXFxxx

Chapter 3 Product Overview and Interface

3.1 I/O functions Introduction

Front View

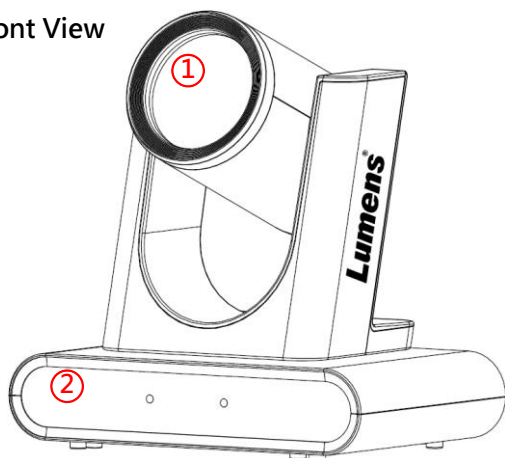

Back View

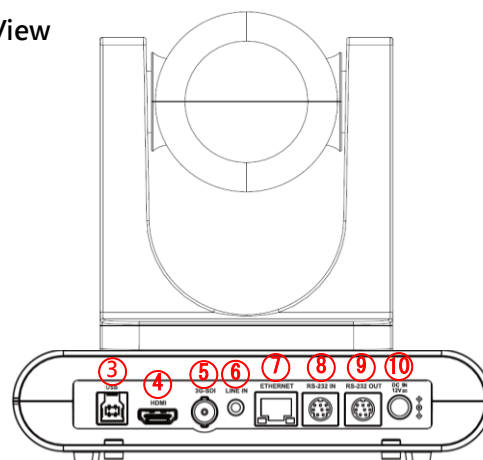

NO.	Item	Function Descriptions
1.	Camera lens	12X HD camera lens
2.	Power/Standby LED indicator	Display the status of the camera
3.	USB3.0 Port	The USB port is for connecting to the USB port of the computer and providing USB signal images
4.	HDMI output	HDMI output <Remark> Audio output is only applicable to VC-R30,V1
5.	3G-SDI output	3G-SDI output <Remark> Audio output is only applicable to VC-R30,V1
6.	Audio In	3.5 mm LINE IN
7.	Network port	Network cable port, supporting PoE (IEEE802.3af) power supply
8.	RS-232 input	RS-232 input port, at most 7 cameras can be connected in a serial connection
9.	RS-232 output	RS-232 output port, at most 7 cameras can be connected in a serial connection
10.	DC 12 V power Port	DC supply connecting port

Bottom

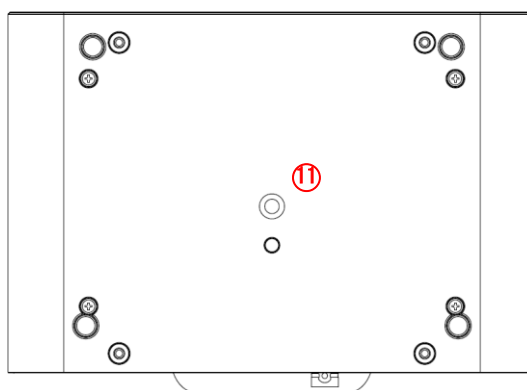

NO.	Item	Function Descriptions
11.	Tripod lock hole	The camera is mounted on a (specification) 1/4" - 20 UNC tripod

3.2 Description of LED indicator

3.2.1 VC-R30

Status	Standby	Power
Powered off	No indicator	No indicator
In use	Green light	Red light
In standby mode	No indicator	Red light
Privacy Mode	Green light (slow flickering)	Red light

3.2.2 VC-R30,V1

Status	Standby	Power
Powered off	No indicator	No indicator
In use	No indicator	Green light
In standby mode	Red light	No indicator
Privacy Mode	No indicator	Green light (flickering)

Chapter 4 Instruction for installation

4.1 Preparation before installation

Installation and connection of HD camera requires special skills. To install by yourself, please follow necessary steps, ensure steady and tight installation of the device, and pay attention to your safety to avoid any accident.

- 4.1.1 Ensure the safety of the installation environment. Please do not install the device on unstable ceiling or in a place where the device is in danger of falling to avoid any accident.
- 4.1.2 Please check whether accessories in the box are complete or not. Please contact the supplier for any shortage, and make sure to keep the accessories in the box intact.
- 4.1.3 Please choose a proper place for installation of camera in advance. Please determine an installation place according to the following requirements
 - 4.1.3.1 Confirm the position for the object to be captured.
 - 4.1.3.2 Confirm whether the camera is set at a proper distance from other light sources.

4.2 Instruction for installation

4.2.1 I would like to install camera on the desk

4.2.1.1 Precautions for installation

- Please install the machine on a flat desk
- Do not grab the camera head by hand when handling the device
- Do not rotate the camera head by hand. Improper rotation may result in breakdown of the camera

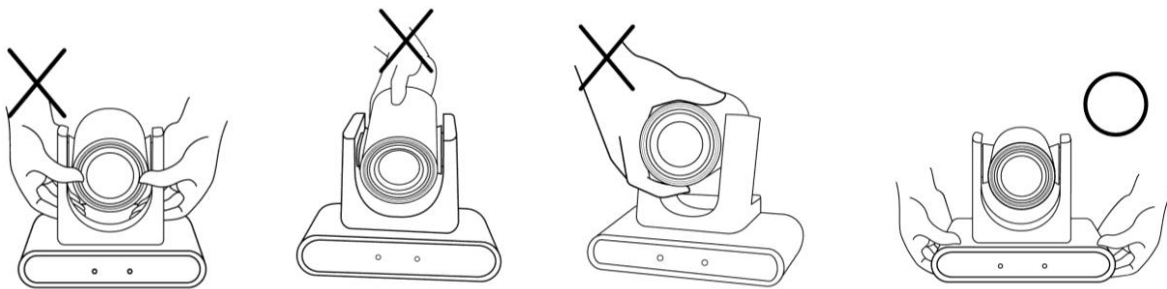

4.2.2 I would like to install the camera on the ceiling/wall/TV stand

Available with VC-WM14 3-in-1 sheet metal, please refer to [VC-WM14 Quick Installation Guide](#)

◆ Install on the TV

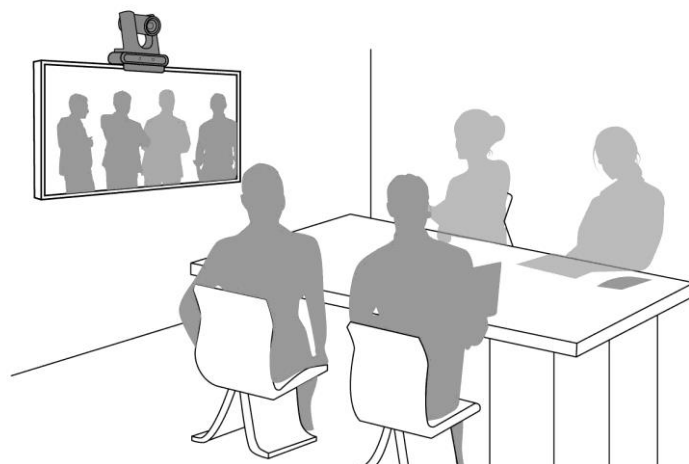

◆ Install on the ceiling

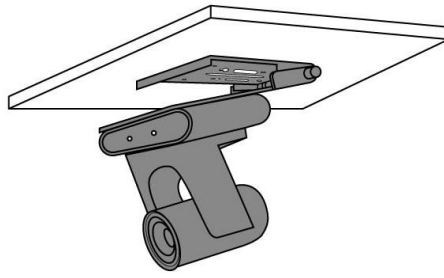

◆ Install on the wall

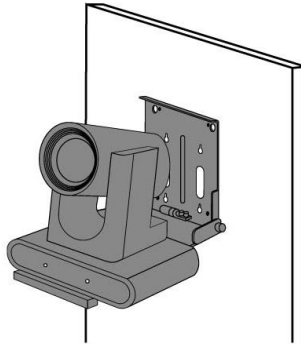

4.2.3 Camera Size

- Length x Width x Height: 190 x 138 x 185 mm
- Weight: 1.3 Kg

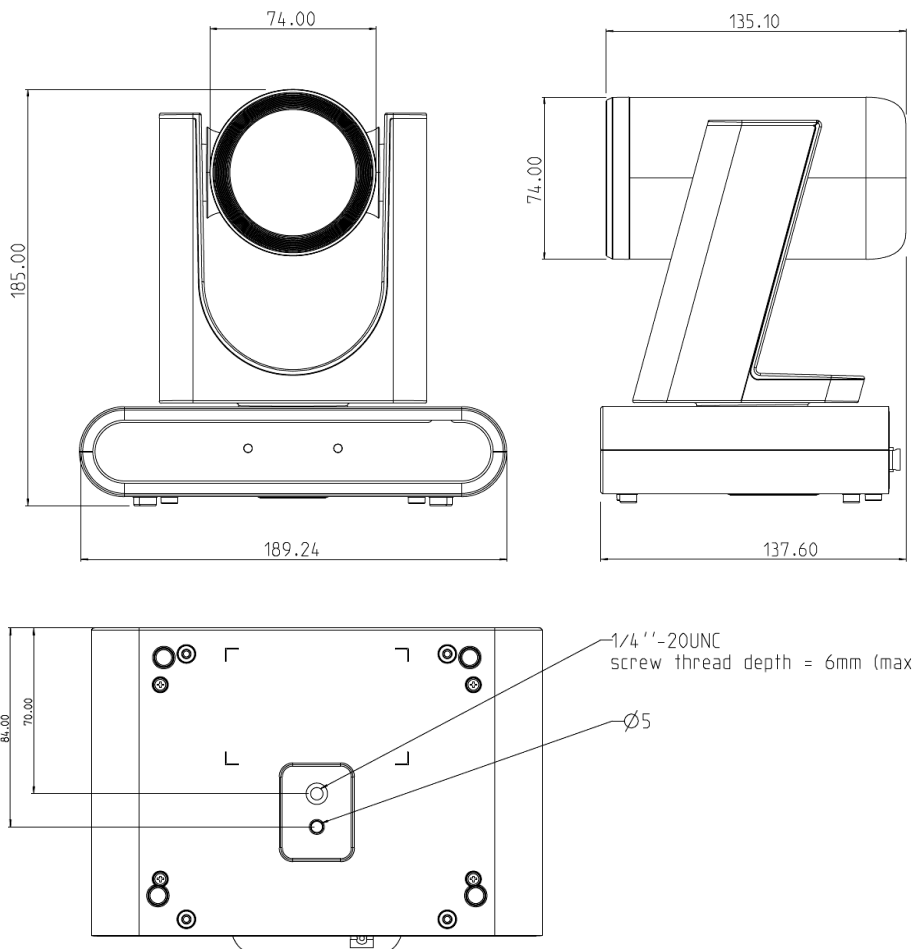

4.2.4 Precautions for installation

- Before installation, please confirm the orientation of the machine relative to the object to be captured
- It is recommended that the machine should be set at a distance of more than 1.5 meter away from the object to be captured. Please adjust for a best distance according to the magnification of the lens

4.3 Connecting devices

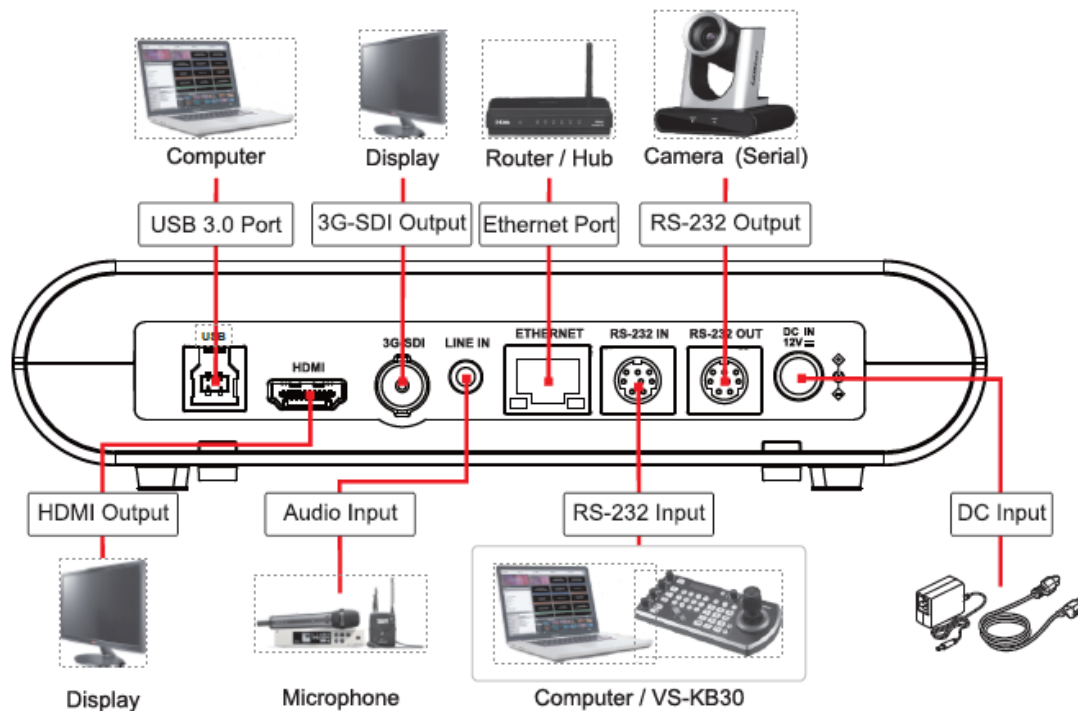

<Remark> Network cable port, supporting PoE (IEEE802.3af) power supply

4.3.1 USB Image Output

Connect to computer with a USB3.0 cable, and use Lumens USB PTZ Camera Controller software to view images and control VC-R30. You can also view images with video software, such as, Skype, Zoom and Microsoft Teams

<Remark> Please visit [Lumens website](#) and go to [Service Support > Download Area](#) to download USB PTZ Camera Controller software

4.3.2 RS-232 Connection

With RS-232 in/out, at most 7 Lumens cameras can be connected.

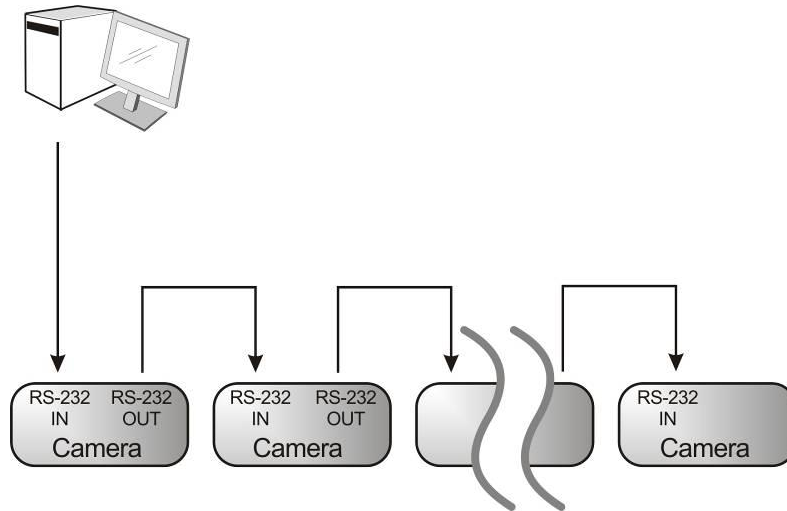

■ RS-232 pins definition instructions

▼ RS-232 IN Pins Instructions

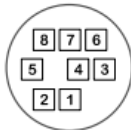

NO	Pins	Signals
1	DTR	Data Transmission Reade
2	DSR	Data Set Reade
3	TXD	Transmit Data
4	GND	Ground
5	RXD	Receive Data
6	GND	Ground
7	IR OUT	IR Commander Signal
8	N.C.	No Connection

▼ RS-232 OUT Pins Instructions

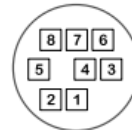

NO	Pins	Signals
1	DTR	Data Transmission Reade
2	DSR	Data Set Reade
3	TXD	Transmit Data
4	GND	Ground
5	RXD	Receive Data
6	GND	Ground
7	OPEN	Reserved
8	OPEN	Reserved

▼ RS-232 Connection Instructions

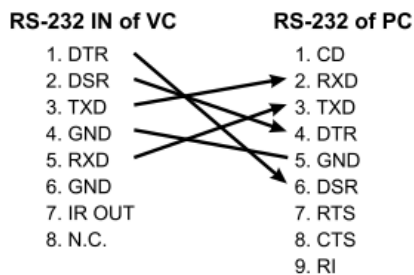

▼ RS-232 Connection Instructions

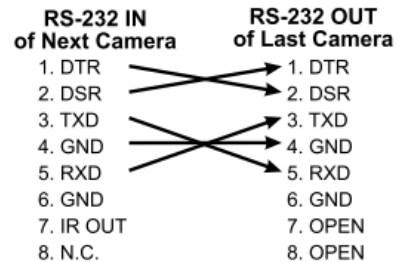

Chapter 5 Introduction of Remote Control and Setting Menu

5.1 Remote Control

- The below functions are listed alphabetically

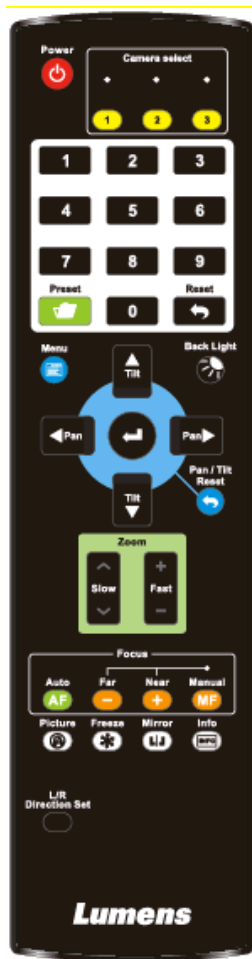

Item	Description
◀, ▶, ▲, ▼	Move the lens
Back Light	Turn on/off back light compensation
Camera select	Choose Camera ID 1 ~ 3
Focus-Manual/ Far/ Near	Enable Manual Focus, adjust the focal length in Manual
Focus-Auto	Auto focus
Freeze	Freeze the screen
Home-Enter	Go back to the main page / Execute
Info	Status information
L/R Direction Set	L/R Direction / Normal
Menu	Display OSD menu
Mirror	Rotate the image (OFF / Mirror / Flip / Rotate)
Pan/Tilt Reset	Clear the Pan/Tilt setting
Picture	Reserve
Power	Power Switch
Preset	Appoint an ID (0 ~ 9) to save the current position data
Reset	Appoint an ID (0 ~ 9) to delete the current position data
Zoom-Fast	Adjust image size
Zoom-Slow	Fine-tune image size

5.2 Setting Menu

<Remark> Press [MENU] on the **remote control** to enter the setting menu; the **bold underlined** values in the following table are defaults.

1st Level Major Items	2nd Level Minor Items	3rd Level Adjustment Values		Function Descriptions
Exposure	Mode	<u>Full Auto</u> / Shutter Pri/ Iris Pri/ Manual/ White Board		Exposure mode setting
	Exposure Comp.	On/ <u>Off</u>		Turn on/off Exposure Comp.
	Exposure Comp. Level	-6~ <u>C</u> ~4		Adjustable after Exposure Comp. is activated
	Spot Light	On/ <u>Off</u>		Turn on/off Spot Light
	Spot Light Position	X(0~6)Y(0~4)		Adjustable after Spot Light is activated
	Shutter Speed	60/30mode 50/25mode		Adjustable when the Exposure mode is set to Shutter Pri or Manual
		1/10000~1/25		
	Iris Level	F1.6~ <u>C</u> ~F14/ Close		Adjustable when the Exposure mode is set to IRIS Pri or Manual
	Gain Limit	8~ <u>30</u> dB		Max. limit value of electron gain
	Gain Level	<u>0</u> ~30dB		Adjustable when the Exposure mode is set to Manual
WDR	<u>Off</u> / 1/ 2/ 3		WDR settings	
White Balance	Mode	<u>1.Auto</u> 2.Indoor 3.Outdoor 4.One Push WB 5.ATW 6.Manual 7.Sodium Lamp		Select the color temperature mode 1. 4000k ~ 7000k 2. 3200k 3. 5800k 4. 1700k ~ 10000k 5. 1700k ~ 10000k 6. Custom 7. 2800k
	One Push Trigger	<u>ENTER</u>		One push trigger
	Manual Red	0~ <u>C</u> ~127		Adjustable when the white balance mode is set to Manual
	Manual Blue	0~ <u>C</u> ~127		Adjustable when the white balance mode is set to Manual
Picture	2D NR	Off/ <u>1</u> / 2/ 3		2D noise reduction
	3D NR	Off/ Low/ <u>Typ</u> / Max		3D noise reduction
	Image Mode	<u>Default</u> / Custom		The user may customize his/her desired image mode

1st Level Major Items	2nd Level Minor Items	3rd Level Adjustment Values	Function Descriptions
	Brightness	0~ <u>A</u> ~15	Adjustable when the <i>Image Mode</i> is set to <i>Custom</i>
	Hue	0~ <u>A</u> ~15	Adjustable when the <i>Image Mode</i> is set to <i>Custom</i>
	Saturation	0~ <u>A</u> ~15	Adjustable when the <i>Image Mode</i> is set to <i>Custom</i>
	Gamma	0~ <u>A</u> ~3	Adjustable when the <i>Image Mode</i> is set to <i>Custom</i>
	Sharpness	0~ <u>A</u> ~14	Adjustable when the <i>Image Mode</i> is set to <i>Custom</i>
Pan Tilt Zoom)	Pan/Tilt Limit	On/ <u>Off</u>	Turn on/off the angle limit setting
	Pan Right Limit	0~ <u>170</u>	Limit the right angle
	Pan Left Limit	<u>-170</u> ~0	Limit the left angle
	Tilt UP Limit	0~ <u>90</u>	Limit the upward angle
	Tilt Down Limit	<u>-30</u> ~0	Limit the downward angle
	Pan Flip	On/ <u>Off</u>	After it is activated, the Pan command will be reverse
	Tilt Flip	On/ <u>Off</u>	After it is activated, the Tilt command will be reverse
	Preset Speed	5/ 25/ 50/ 80/ 120 deg/sec	Set the rotation speed of the cradle head when Preset is executed
	PTZ Speed Comp	On/ <u>Off</u>	After it is activated, the Pan/Tilt moving speed will vary from the zoom position
	D-Zoom Limit	<u>x1</u> ~x12	Set the D-zoom limit
D-Effect	Mirror	<u>Off</u> / Mirror/ Flip/ Mirror+Flip	Set the mode at which the image is turned
Auto Focus	AF Sensitivity	Low/ <u>Middle</u> / High	For AF triggering speed, the higher the sensitivity is, the faster AF is triggered
	AF Frame	Center/ Full Frame/ <u>Auto</u>	AF frame setting, when <i>Center</i> was set as AF frame, focusing will be on the center of the screen. When Full Frame was set as AF frame, focusing will be calculated based on the full screen
Ethernet	DHCP	<u>On</u> /Off	Enable/Disable the dynamic host configuration
	IP Address	<u>192.168.100.100</u>	Configurable when <i>DHCP</i> is set to <i>Off</i>
	Subnet mask	<u>255.255.255.0</u>	
	Gateway	<u>192.168.100.254</u>	
Audio	Audio Enable	On/ <u>Off</u>	Turn on/off audio output
	Audio In	<u>Line In</u> / Mic In	<Remark> Only applicable to VC-R30,V1
	Audio Volume	0~ <u>A</u> ~10	Volume Setting

1st Level Major Items	2nd Level Minor Items	3rd Level Adjustment Values	Function Descriptions
	Audio Delay	On/ <u>Off</u>	When the audio is not synchronized with the video, enable this function to set the audio delay time
	Audio Delay Time(ms)	<u>-10</u> ~-500ms	Set audio delay time
	Encode Sample Rate	48/ 44.1/ <u>16</u> KHz(AAC)	Set the encode type and sample rate <Remark> 44.1/16 KHz is only applicable to VC-R30
System	Prompt	On/ <u>Off</u>	Turn on/off the prompt information on the display
	IR Receive	<u>On</u> /Off	Turn on/off the infrared reception When it is Off, the remote control will not be able to control the camera. At this moment, turn off and then turn on the power to restore control of the remote control.
	IR Select	<u>1</u> / 2/ 3	Camera IR Select setting must be the same setting as the Camera Select of the remote control to control the camera
	Language	<u>English</u>	
	Initial Position	<u>Last MEM</u> / 1st Preset	After turning on the camera, you can select the lens to be returned to Last MEM or 1st Preset <Remark> 1st Preset =Preset 0
	Motionless Preset	On/ <u>Off</u>	When the function is enabled, the screen will Freeze when Preset is executed. Freeze will be released after Preset is completed
	Privacy Mode	On/ <u>Off</u>	Enable/Cancel Privacy Mode After the function is enabled, when the camera is turned off via the remote control or software, the lens will automatically turn to the bottom right to ensure the user's privacy
	Protocol	<u>VISCA</u>	
	Baud Rate	<u>9600</u> /38400	Choose the transmission speed of the control signal
	VISCA Address	<u>1~7</u>	The camera ID address can be assigned. Select 0 for automation.
	Output Mode	<u>1080p 60</u> /50/30/25 720p 60/50/ 1080i 60/50	Choose the output resolution <Remark> 1080i 60/50 is only applicable to VC-R30
Factory Reset)	On/ <u>Off</u>	Resume the factory default setting	
Status			Display the current setting status

Chapter 6 Network Function Settings Description

6.1 Web System Requirements

Operating System	Version	Browser
Windows	7 (64 bits) and above	FireFox
		Chrome
	10 (64 bits) and above	Edge
		FireFox
Mac	10.14 and above	Safari
		Chrome
		FireFox

6.2 Connecting Camera to Network

6.2.1 Connecting to Internet

Two common connection methods are shown below

1. Connecting via switch or router

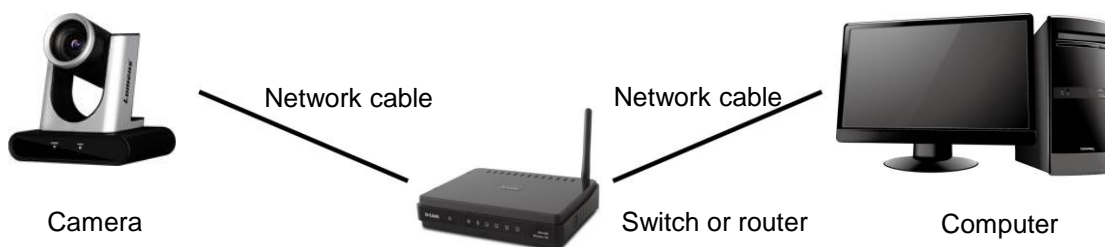

2. To connect directly through network cable, the IP address of the computer should be changed so that it is on the same network segment as the camera

E.g.: The factory-preset default IP address of the camera is 192.168.100.100. The computer IP address must be set with the same network segment, such as 192.168.100.101, so that the computer can be connected correctly with the camera

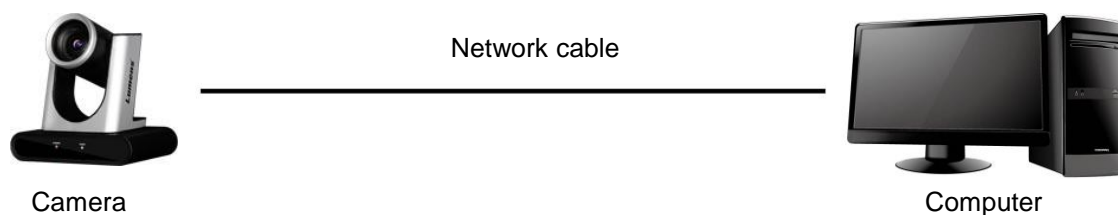

- Change network settings

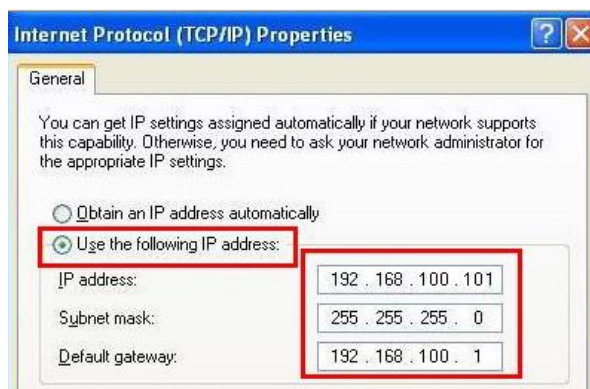

6.2.2 Using the Browser to View the Images

- Open the browser, and enter the IP address of the camera in the address bar
E.g.: <http://192.168.100.100> (default IP address)
- Enter administrator's account and password

<Remark> For the first-time login, please refer to [6.3.9 System Settings - User](#) to change the default password

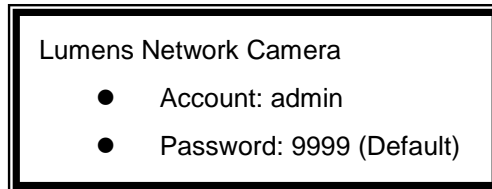

6.2.3 Using RTSP Player to View the Images

Free software can be used for RTSP connection, such as VLC, Quick Time and PotPlayer
RTSP connection address formats are as follows:

- RTSP Sub1 Streaming => <rtsp://camera IP:8557/h264>
- RTSP Sub2 Streaming => <rtsp://camera IP:8556/h264>

If password authentication is enabled, the RTSP connection address is as follows:

- <rtsp://Username:Password@VC IP address:port/h264>
- To enable password authentication function, please refer to [6.3.5 Streaming](#)

Example:

Open the VLC software, click [Open Network Streaming], and enter the URL:

<rtsp://192.168.100.150:8557/h264>

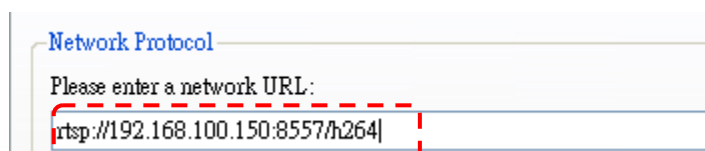
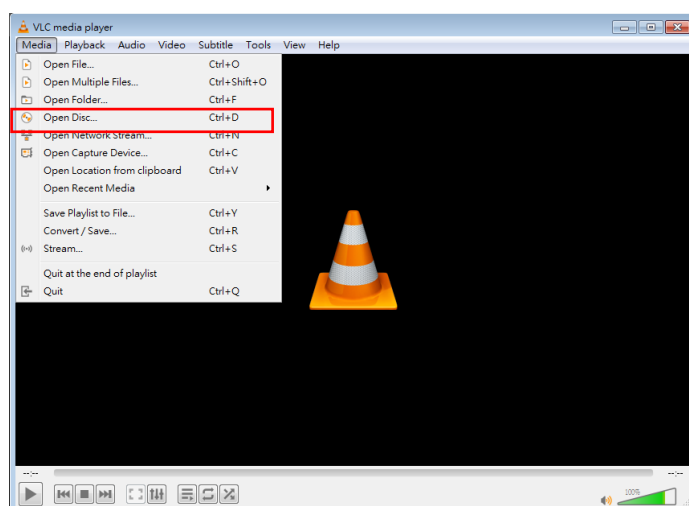

6.3 Web Page Menu Function Description

6.3.1 Login Screen



No	Item	Function Descriptions
1	User Login Account	Enter user login account (default: admin)
2	User Password	Enter user password (default: 9999) <Remark> For the first-time login, please refer to 6.3.9 System Settings - User to change the default password
3	Remember user account and password	Save user login account and password to the browser. When you log in next time, there is no need to re-enter them
4	Language	Supporting English/Traditional Chinese/Simplified Chinese
5	Login	Log into the administrator screen on the website

6.3.2 Live Video – PTZ Control

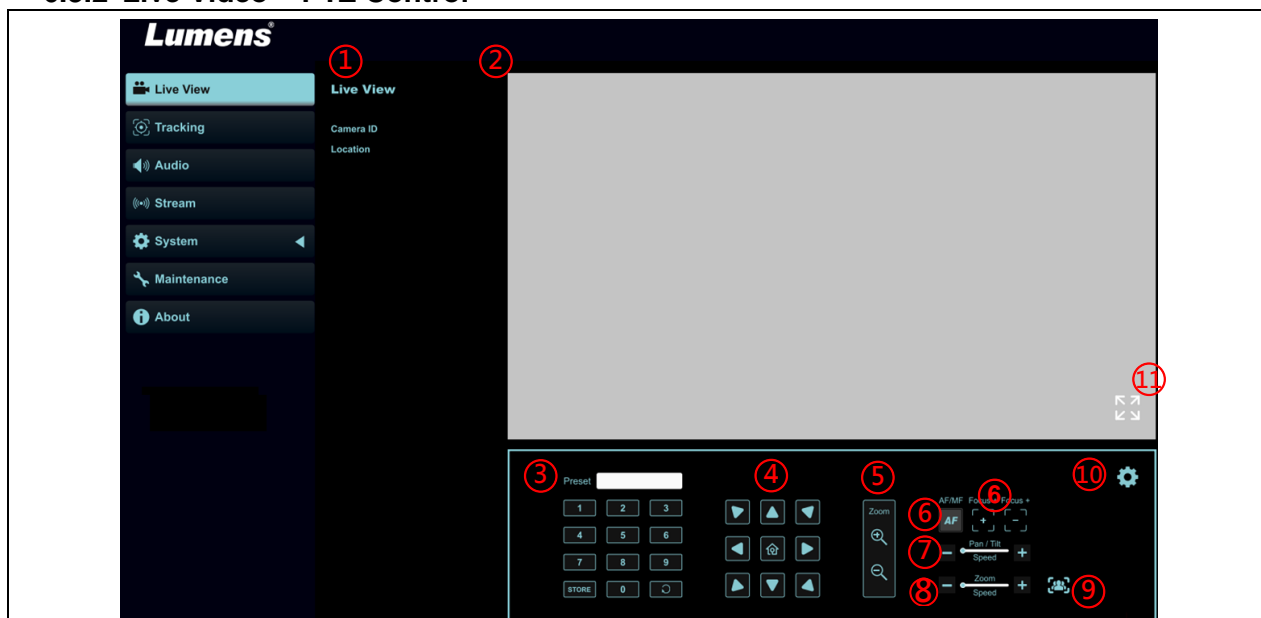

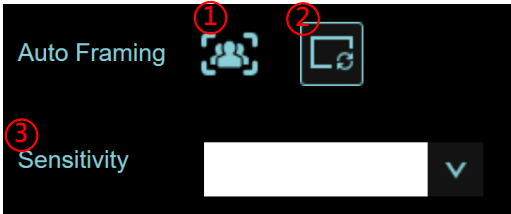

No	Item	Function Descriptions
1	Camera ID/location	Display camera ID/location Please refer to 6.3.6 System Settings - Output Setting
2	Preview window	Display the screen currently captured by the camera

3	Preset setting	Select the number first and then select SAVE or LOAD
4	Pan/Tilt setting	Adjust the Pan/Tilt position of the camera screen
5	Zoom	Zoom In/Zoom Out ratio
6	AF/MF	Switch AF/MF
7	Zoom speed	Adjust the zoom speed
8	Pan/ Tilt Speed	Adjust the horizontal/vertical moving speed of the lens
9	Auto Framing	<p><Remark> Auto Framing is only applicable to VC-R30,V1</p> <p>Enable smart viewfinder setting</p>  <ol style="list-style-type: none"> 1. Enable/Disable Smart viewfinder 2. Correction: If the image is not zoomed according to the actual number of people, please click to perform viewfinder correction 3. Sensitivity: Set tracking sensitivity
10	Camera Setting	Please refer to 6.3.3 Live Video - Camera Setting for related settings
11	Enlarge the preview window	Zooming in/out the preview image

6.3.3 Live Video - Camera Setting

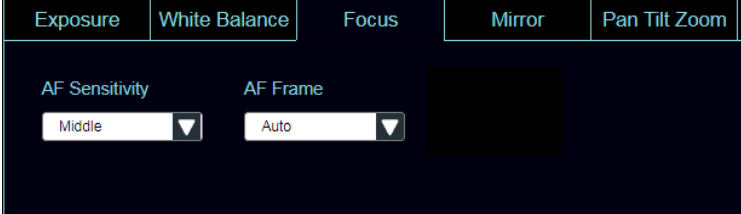
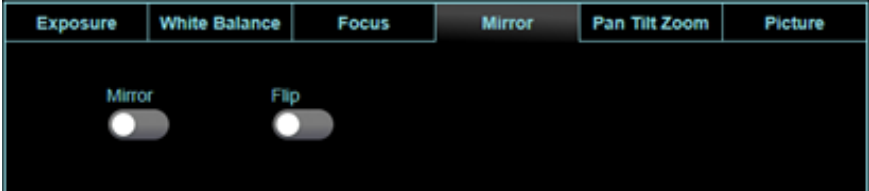

No	Item	Function Descriptions
1	Exposure	<ul style="list-style-type: none"> ■ Mode: Select exposure mode (Full Auto/Shutter Pri/Iris Pri/Manual/ White Board) ■ Gain Level: Adjust the gain level (adjustable only under the “Manual”) ■ Gain Limit: Adjust the gain limit (adjustable only under the “Manual”) ■ Exposure Comp. Level: Select exposure compensation level ■ WDR: Set the level of wide dynamic range (WDR) in order to obtain better images ■ Iris Level: Adjust the size of aperture (adjustable only under the “Manual” or “Aperture Priority”) ■ Shutter Speed: Adjust the shutter speed (adjustable only under the “Manual” or “Shutter Priority”)

2	White Balance	 <ul style="list-style-type: none"> ■ Mode: Select the color temperature mode ■ Open Push WB: Single color temperature execution adjustment (adjustable only under the “One Push WB”) ■ Manual Red/Blue: Manually adjust blue/red color temperature
3	Focus	 <ul style="list-style-type: none"> ■ AF Sensitivity: Set automatic focus sensitivity ■ AF Frame: Set automatic focus range
4	Mirror	 <ul style="list-style-type: none"> ■ Mirror: Set image mirroring ■ Flip: Set image flip
5	Pan Tilt Zoom	 <ul style="list-style-type: none"> ■ Pan/Tilt limit: Enable, and set the pan/tilt limit ■ Preset Speed: Set the rotation speed of the cradle head when Preset is executed ■ PTZ Speed Comp: After it is activated, the Pan/Tilt moving speed will vary from the zoom position ■ Initial Position: Set the camera lens to return to Last MEM or 1st Preset after POWER ON <Remark> 1st Preset = Preset 0 ■ Motionless Preset: When the function is enabled, the screen will Freeze when Preset is executed. Freeze will be released after Preset is completed ■ D-Zoom Limit: Set the D-Zoom Limit

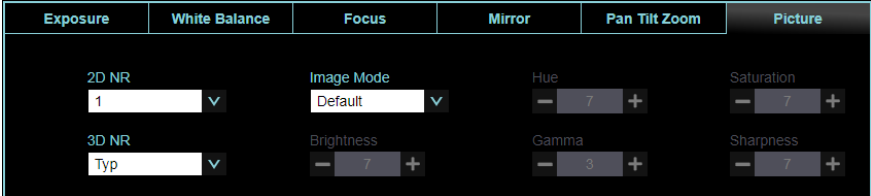
6	Picture	 <ul style="list-style-type: none"> ■ 2D noise reduction: 2D noise reduction settings ■ 3D noise reduction: 3D noise reduction settings ■ Image Mode: The user may customize his/her desired image mode ■ Brightness: Brightness adjustment of the image; Adjustable when the image mode is set to Custom ■ Hue: Hue adjustment of the image; Adjustable when the image mode is set to Custom ■ Gamma: Gamma Level adjustment; Adjustable when the image mode is set to Custom ■ Saturation: Saturation adjustment of the image; Adjustable when the image mode is set to Custom ■ Sharpness: Sharpness adjustment of the image; Adjustable when the image mode is set to Custom
7	PTZ Control	Go back to PTZ Control page

6.3.4 Audio

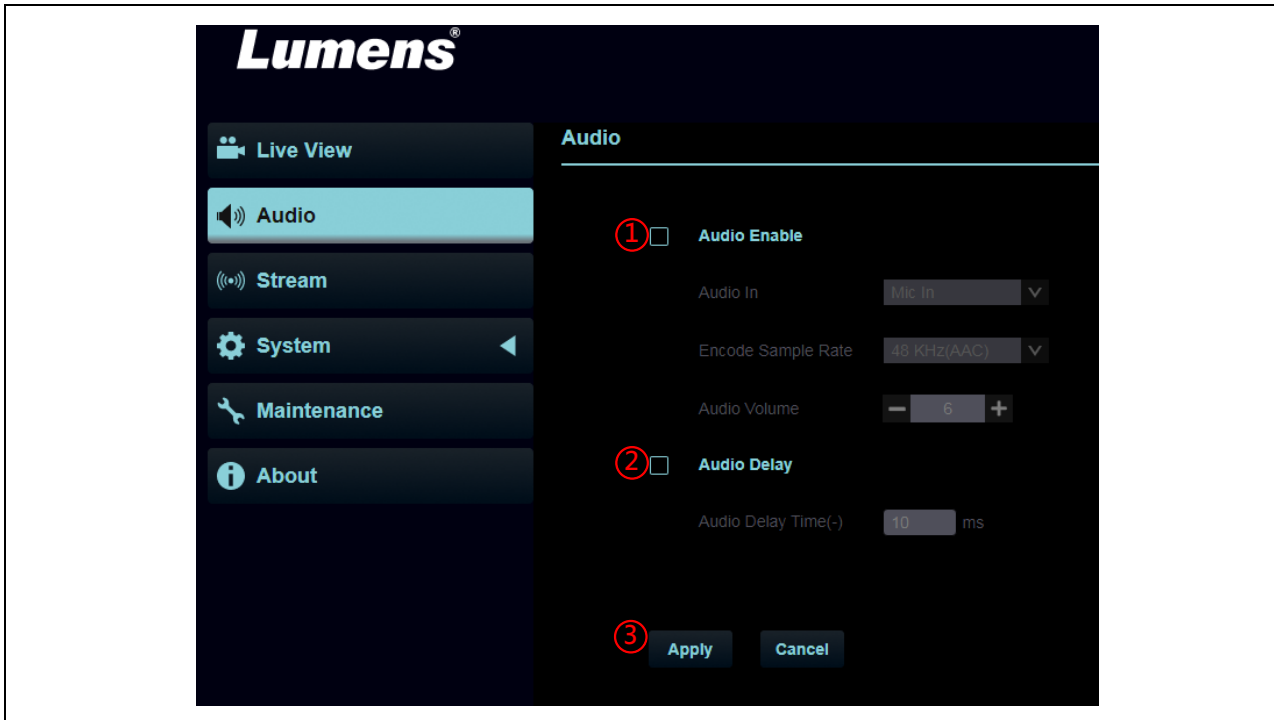

No	Item	Function Descriptions
1	Audio Enable	Select to enable Audio function <ul style="list-style-type: none"> ■ Audio In: Set Line In / Mic In <Remark> Only applicable to VC-R30,V1 ■ Encode sample rate: Set the encode type and sample rate <Remark> 44.1/16 KHz is only applicable to VC-R30 ■ Volume: Adjust Audio Volume
2	Audio Delay	After checking the box, set the audio delay time (10 ~ -500 ms)
3	Apply/Cancel	Apply/Cancel Audio Setting

6.3.5 Streaming

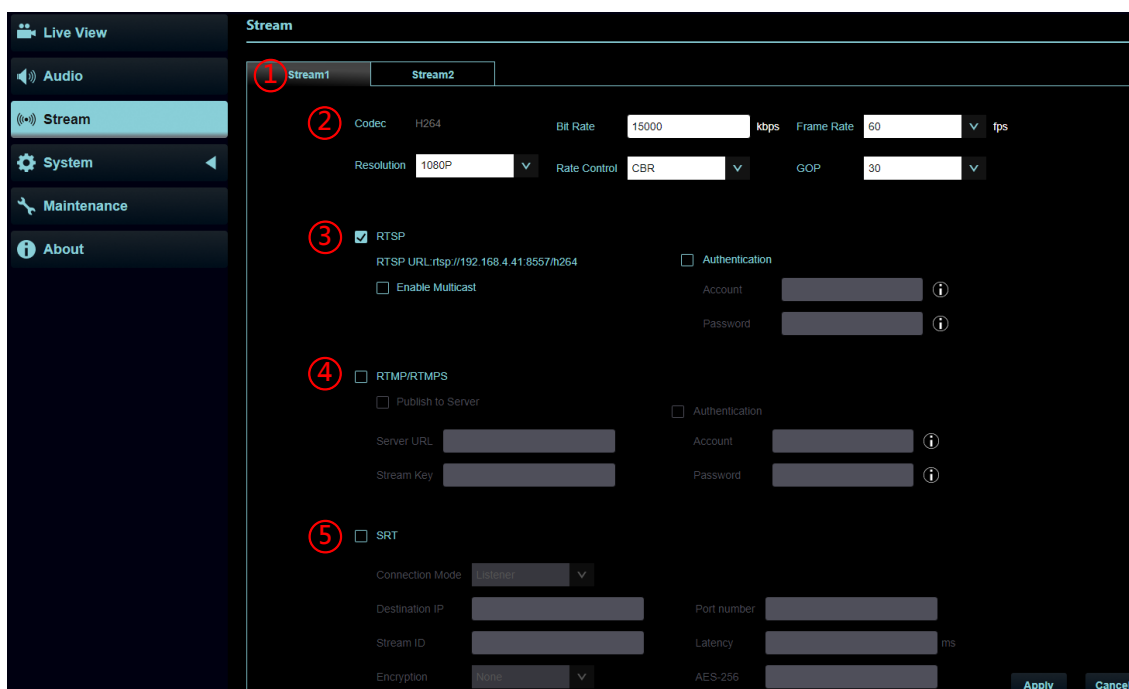

No	Item	Function Descriptions
1	Streaming 1/ Streaming 2	Supporting 2-way streaming output
2	Streaming parameter setting	Please refer to 6.3.5.1 Streaming Parameter Setting for relevant settings
3	RTSP	<p>Select to enable RTSP</p> <ul style="list-style-type: none"> ■ Enable/Disable Multicast It is suggested to enable Multicast when the number of users online watching the live image simultaneously is more than 4 ■ Enable/Disable Password Authentication ➤ RTSP connection format can be found in 6.2.3 Using RTSP Player to View the Images
4	RTMP/ RTMPS	<p>Select to enable RTMP/RTMPS</p> <ul style="list-style-type: none"> ■ Enable/Cancel Password Authentication
5	SRT	<p><Remark> Only applicable to VC-R30,V1; Streaming 1 supports SRT Transmission</p> <p>Select to enable SRT</p> <ul style="list-style-type: none"> ■ The port number must be set in the range above 1024 with a maximum value of 9999 <Remark> The following port is to be used by the camera. Setting of the said port may not connect correctly 8554, 8556, 8557, 8080, 9090, 1935 ■ Delay time is for 20 to 8000 microseconds. The default value is 120 microseconds

6.3.5.1 Streaming parameter setting

Function		Streaming 1	Streaming 2
Encode Format		H.264	
Resolution		1080p / 720p	720p
Bit rate	Range	2,000~20,000	2,000~20,000
	Factory Default	7,000	3,000
Rate Control		CBR / VBR	
Frame Rate		Setting according to the supported resolution	
Group of Pictures		Setting according to the supported resolution	

6.3.6 System Settings – Output Setting

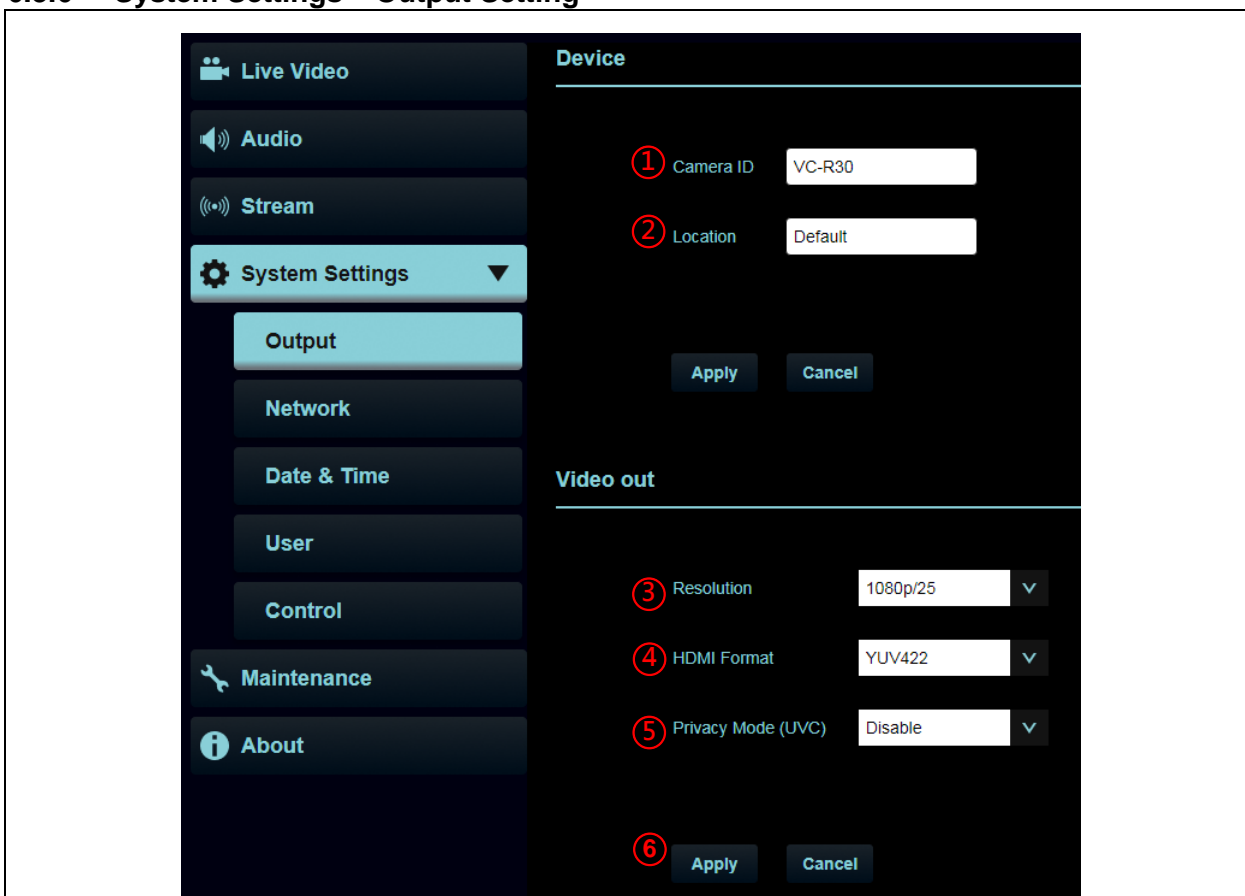

No	Item	Function Descriptions
1	Camera name	Change camera name here <ul style="list-style-type: none"> ■ Supporting 1 - 12 characters for the camera name ■ Please mix uppercase and lowercase letters or numbers for characters. Special symbols such as “/” and “space” cannot be used
2	Camera Location	Modify the location of the camera, such as Room 1 <ul style="list-style-type: none"> ■ Supporting 1 - 12 characters for the camera location ■ Please mix uppercase and lowercase letters or numbers for characters. Special symbols such as “/” and “space” cannot be used
3	Resolution	Set the resolution of the camera After switching the resolution, the camera will restart. Please refresh the browser
4	HDMI format	Select YUV422/ RGB
5	Privacy Mode	Enable/Cancel Privacy Mode

	(UVC)	After the function is enabled, when the camera is turned off via the remote control or software, the lens will automatically turn to the bottom right to ensure the user's privacy
6	Apply/Cancel	Apply/Cancel Setting

6.3.7 System Settings – Network

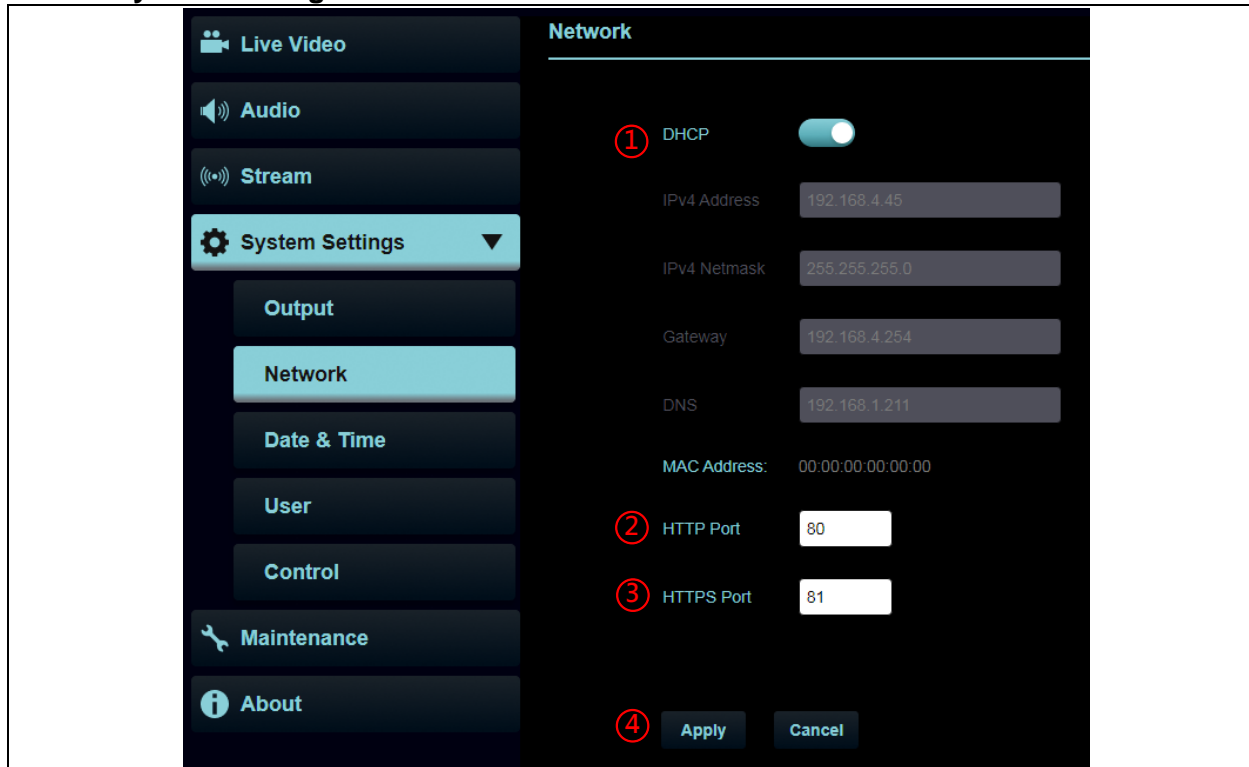

No	Item	Function Descriptions
1	DHCP	Network setting of camera. Change of setting is available when DHCP function is closed
2	HTTP port number	Set HTTP port. The default Port value is 80
3	HTTPS port number	Set HTTPS port. The default Port value is 81
4	Apply/Cancel	Apply/Cancel Setting

6.3.8 System Settings - Date & Time

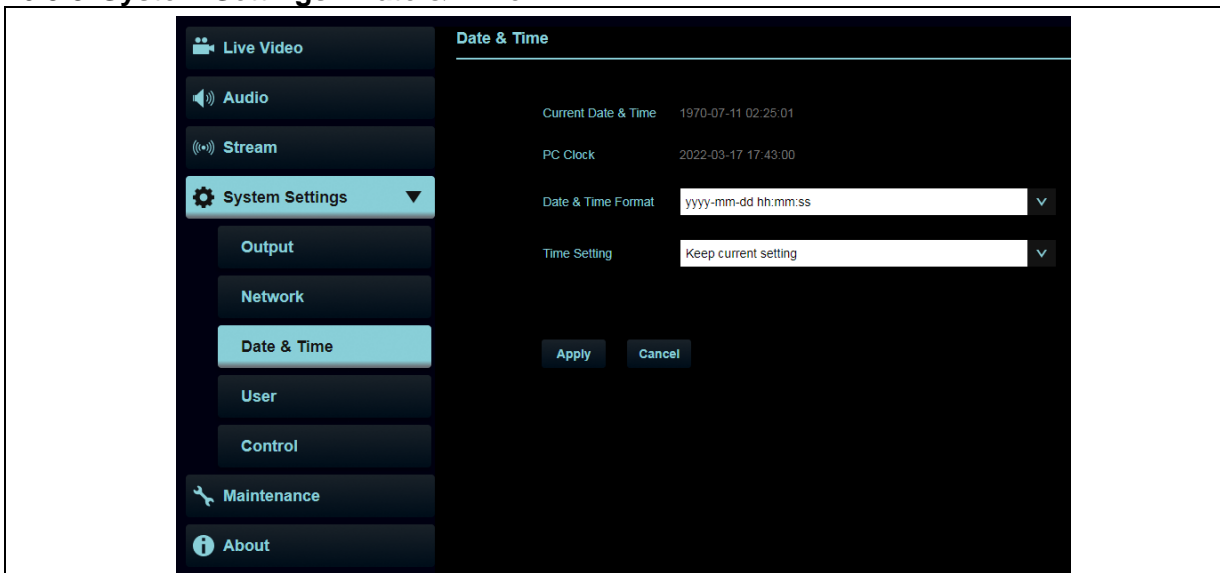

Function Descriptions

Display the current camera/PC date and time, and set the display format and synchronization way
 When Manually Set is selected for [Time Settings], Date & Time can be customized

6.3.9 System Settings – User

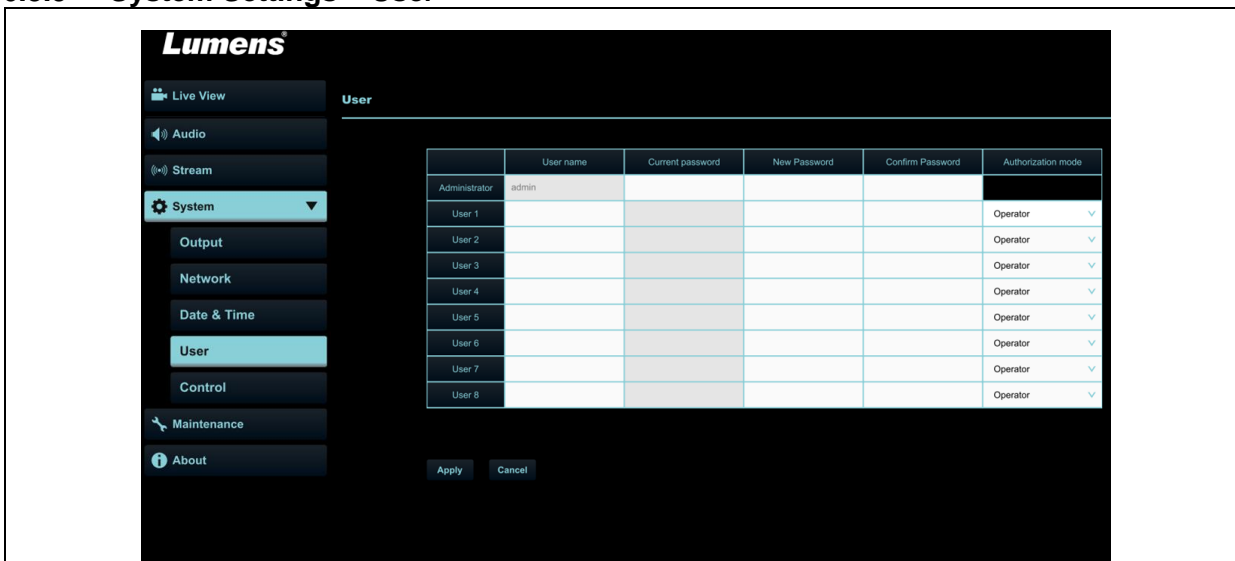

Function Descriptions

Add/Modify/Delete user account

- Supporting 4 - 32 characters for user name and password
- Please mix uppercase and lowercase letters or numbers for characters. Special symbols **or the underlined** cannot be used
- Authentication Mode: Set the new account management permissions

User Type	Administrator (Admin)	Operator (Operator)	Viewer (Viewer)
View images	V	V	V
Settings	V	V	X
Account management	V	X	X

6.3.10 System Settings – Control

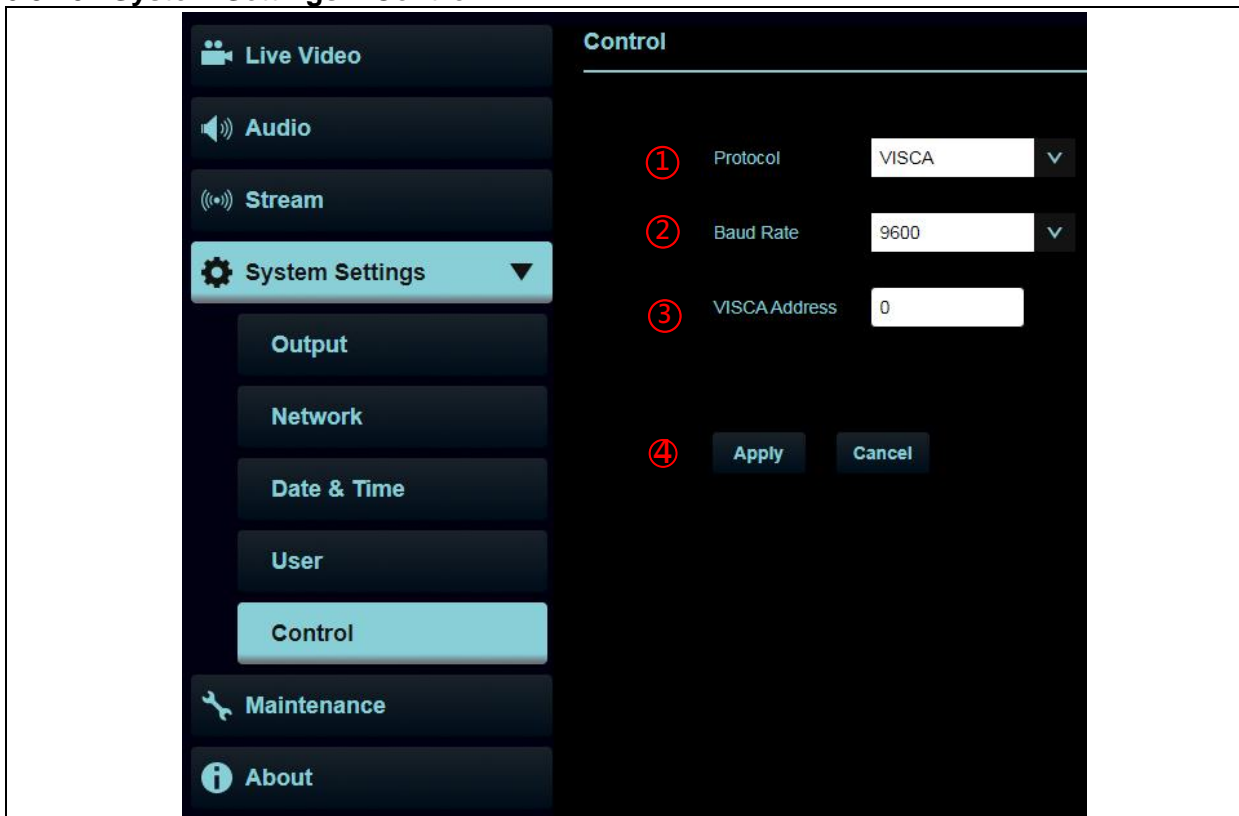

No	Item	Function Descriptions
1	Protocol	Supporting VISCA protocol
2	Baud Rate	Choose the transmission speed of the control signal as 9600/38400
3	VISCA address	The camera ID address 1~7 can be assigned.
4	Apply/Cancel	Apply/Cancel Setting

6.3.11 Maintenance

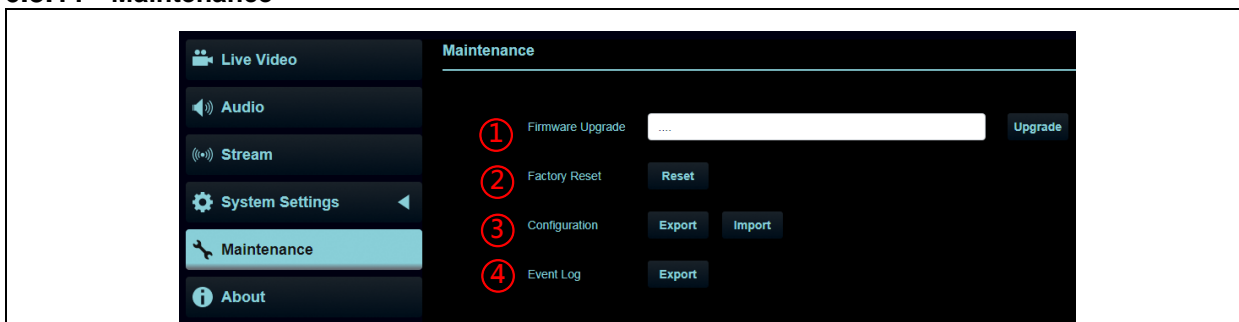

No	Item	Function Descriptions
1	Firmware Upgrade	Select the firmware file, and click [Upgrade] to update the firmware. <Remark> Update takes about 2-3 minutes. <Remark> Please do not operate o-r turn off the power of the device during the update to avoid firmware update failure.
2	Factory Reset	Reset all configurations to factory default settings.
3	Configuration	Save setup parameters as a Profile, and users can download and upload camera setup parameters
4	Event Log	If the machine operates abnormally, the event log can be exported for reference of Lumens technicians

6.3.12 About



Function Descriptions

Display the firmware version, serial number, and other related information of the camera
For technical support, please scan the QRcode at the bottom right.

Chapter 7 Troubleshooting

This chapter describes problems you may encounter while using VC-R30. If you have questions, please refer to related chapters and follow all the suggested solutions. If the problem still occurred, please contact your distributors or the service center.

No.	Problems	Solutions
1.	Boot without power signal	1. Make sure you have plugged in the power cord. 2. When using a PoE connection, ensure that the power supply supports PoE (IEEE802.3af) hubs
2.	There is no image output from camera	1. Check the power supply or PoE supply functions. 2. Confirm the output signals are in streaming output. 3. Confirm whether the camera resolution can be used together with the monitor equipment 4. Replace the cables and make sure they are not faulty.
3.	Camera image is severely delayed	Please use 1080p or 720p 60/50 fps rather than 25/30 fps signals.
4.	RS-232 cannot be controlled	1. Confirm the connection is correct (RS-232 In/ Out) 2. Please make sure the Baud rate setting is the same as the control equipment
5.	Whether the Internet can be used for operation	Please refer to Chapter 6 Network Function Settings Description for the Internet usage
6.	The camera does not save the relevant parameters (PTZ, AWB ...) after reboot	Please make sure if the Initial Position is set to Last Operated Position from the setting menu or web page Setting Menu: System-Initial Position Web page: Live Video - Camera - Pan Tilt Zoom
7.	VC-R30 cannot be operated by remote control	1. Please make sure the IR Select setting in the camera menu is the same setting as the Camera Select of the remote control 2. Please try to replace the batteries of the remote control 3. Please prevent VC-R30 from direct sunshine 4. Make sure the energy-saving bulb and the IR touch screen are as far as possible in order to avoid interference 5. When several VC-R30 are connected in the same area, the operation of two remote controls at the same time may result in signal interference. It is recommended to use one remote control only

Chapter 8 Safety Instructions

Always follow these safety instructions when setting up and using VC-R30 PTZ Video Camera:

1 Operation

- 1.1 Please use the product in the recommended operating environment, away from water or source of heat
- 1.2 Do not place the product on a tilted or unstable trolley, stand or table.
- 1.3 Please clean the dust on the power plug prior to usage. Do not insert the product's power plug into a multiplug to prevent sparks or a fire.
- 1.4 Do not block the slots and openings in the case of the product. They provide ventilation and prevent the product from overheating.
- 1.5 Do not open or remove covers, otherwise it may expose you to dangerous voltages and other hazards. Refer all servicing to licensed service personnel.
- 1.6 Unplug the product from the wall outlet and refer servicing to licensed service personnel when the following situations happen:
 - If the USB port becomes damaged or frayed.
 - If liquid is spilled into the product or the product has been exposed to rain or water.

2 Installation

- 2.1 For security considerations, please make sure the standard mount you use is in line with UL or CE safety approbations and installed by technician personnel approved by agents.

3 Storage

- 3.1 Do not place the product where the cord can be stepped on as this may result in fraying or damage to the lead or the plug.
- 3.2 Unplug this product during thunderstorms or if it is not going to be used for an extended period.
- 3.3 Do not place this product or accessories on top of vibrating equipment or heated objects.



4 Cleaning

- 4.1 Disconnect all the cables prior to cleaning and wipe the surface with a dry cloth. Do not use alcohol or volatile solvents for cleaning.

5 Batteries (for products or accessories with batteries)

- 5.1 When replacing batteries, please only use similar or the same type of batteries.
- 5.2 When disposing of batteries or products, please adhere to the relevant instructions in your country or region for disposing of batteries or products.

■ Precautions

	This symbol indicates that this equipment may contain dangerous voltage which could cause electric shock. Do not remove the cover (or back). No user-serviceable parts inside. Refer servicing to licensed service personnel.		This symbol indicates that there are important operating and maintenance instructions in this User Manual with this unit.
---	---	--	---

■ FCC Warning

This equipment has been tested and found to comply with the limits for a Class A digital device, pursuant to part 15 of the FCC Rules. These limits are designed to provide reasonable protection against harmful interference when the equipment is operated in a commercial environment.

Notice :

The changes or modifications not expressly approved by the party responsible for compliance could void the user's authority to operate the equipment.

This equipment has been tested and found to comply with the limits for a Class A digital device, pursuant to part 15 of the FCC Rules. These limits are designed to provide reasonable protection against harmful interference when the equipment is operated in a commercial environment.

■ IC Warning

This digital apparatus does not exceed the Class A limits for radio noise emissions from digital apparatus as set out in the interference-causing equipment standard entitled "Digital Apparatus," ICES-003 of Industry Canada.

Cet appareil numerique respecte les limites de bruits radioelectriques applicables aux appareils numeriques de Classe A prescrites dans la norme sur le material brouilleur: "Appareils Numeriques," NMB-003 edictee par l'Industrie.

■ EN55032 CE Warning

Operation of this equipment in a residential environment could cause radio interference.

Warning: Operation of this equipment in a residential environment may cause radio interference

Supplier's Declaration of Conformity

47 CFR § 2.1077 Compliance Information

Manufacturer : Lumens Digital Optics Inc.

Product Name : VC-R30

Model Number : PTZ Video Camera

Responsible Party – U.S. Contact Information

Supplier : Lumens Integration, Inc.

4116 Clipper Court, Fremont, CA 94538, United States

e-mail : support@mylumens.com

FCC Compliance Statement

This device complies with Part 15 of the FCC Rules. Operation is subject to the following two conditions : (1) This device may not cause harmful interference, and (2) this device must accept any interference received, including interference that may cause undesired operation.

Copyright Information

Copyrights © Lumens Digital Optics Inc. All rights reserved.

Lumens is a trademark that is currently being registered by Lumens Digital Optics Inc.

Copying, reproducing or transmitting this file is not allowed if a license is not provided by Lumens Digital Optics Inc. unless copying this file is for the purpose of backup after purchasing this product.

In order to keep improving the product, the information in this file is subject to change without prior notice.

To fully explain or describe how this product should be used, this manual may refer to names of other products or companies without any intention of infringement.

Disclaimer of warranties: Lumens Digital Optics Inc. is neither responsible for any possible technological, editorial errors or omissions, nor responsible for any incidental or related damages arising from providing this file, using, or operating this product.