



## SpeechLine Wired MAT 133, MAT 133-S, MAT 153-S - Tablestand

**MAT 133****MAT 133-S****MAT 153-S**

### FEATURES

- Timeless Design
- Bi-color light ring for clear visual feedback
- Switchable microphone modes
- Logic port for seamless integration
- Made in Germany

The MAT 133 is a rugged and unobtrusively designed tablestand. It provides a solid ground for XLR3 gooseneck microphones.

The MAT 133-S provides a convenient microphone button that is featured with a bi-color light ring for clear visual feedback. The TTL-logic output serves for various control purposes such as camera control. The MAT 133-S is as versatile as it is easy to operate.

The MAT 153-S provides solid ground for XLR-5 gooseneck microphones.

### ARCHITECT'S SPECIFICATION

The tablestand for connecting and operating XLR gooseneck microphones shall be rugged and unobtrusive. It shall feature an XLR-3F microphone input and an XLR-3M microphone output. The tablestand shall operate on 48 V phantom power. Current consumption shall be 1.9 mA. Dimensions shall be 120 x 170 x 43 mm (4.72" x 6.69" x 1.69"). Weight shall be 1,210 grams (42,68 oz). Operating temperature shall range from -10 °C to +50 °C (+14 °F to +122 °F). The tablestand shall be the Sennheiser MAT 133.

The Sennheiser MAT 133 shall also be available as a variant (-S) with a programmable microphone button (Toggle on/off, PTM, PTT and permanent on) and a bi-color LED ring for status indication. The current consumption of the -S version shall be 3.7 mA. The tablestand shall provide a TTL logic connector with logic inputs and outputs. The logic output voltage shall be high level > 2.4 and low level < 0.4 V, the logic input voltage shall be high level > 2.0 V and low level < 0.8 V.







The tablestand for connecting and operating XLR gooseneck microphones shall be rugged and unobtrusive. It shall have a programmable microphone button (Toggle on/off, PTM, PTT and permanent on) and a bi-color LED ring for status indication shall be provided. The tablestand shall feature an XLR-5F microphone input, an XLR-5M microphone output and a TTL logic connector with logic inputs and outputs. The logic output voltage shall be high level > 2.4 and low level < 0.4 V, the logic input voltage shall be high level > 2.0 V and low level < 0.8 V. The tablestand shall operate on 48 V phantom power. Current consumption shall be 3.7 mA. Dimensions shall be 120 x 170 x 43 mm (4.72" x 6.69" x 1.69"). Weight shall be 1,210 grams (42,68 oz). Operating temperature shall range from -10 °C to +50 °C (+14 °F to +122 °F). The tablestand shall be the Sennheiser MAT 153-S.



# SpeechLine Wired

## MAT 133, MAT 133-S, MAT 153-S - Tablestand

### SPECIFICATIONS

	<b>MAT 133</b>	<b>MAT 133-S</b>	<b>MAT 153-S</b>
Phantom power	P 24		
Current consumption	1.9 mA	3.7 mA	3.7 mA
Connectors	Mic In - XLR-3F Mic Out - XLR-3M	Mic In - XLR-3F Mic Out - XLR-3M	Mic In - XLR-5F Mic Out - XLR-3M
Pin assignment out	XLR-3M out 1 = gnd 2 = Audio + 3 = Audio -	XLR-3M out 1 = gnd 2 = Audio + 3 = Audio -	XLR-3M out 1 = gnd 2 = Audio + 3 = Audio -
Pin assignment in	XLR-3F in 1 = gnd 2 = Audio (+) 3 = Audio (-)	XLR-3F in 1 = gnd 2 = Audio (+) 3 = Audio (-)	XLR-5F in 1 = gnd 2 = Audio (+) 3 = Audio (-) 4 = LED 5 = LED (+)
LED light ring color		red/green	red/green
Microphone modes		Toggle on / off Push to mute Push to talk permanent on	Toggle on / off Push to mute Push to talk permanent on
Connection		clip contact for logic	clip contact for logic
Pin assignment logic connector		trigger signal at the logic connector:  Logic in (external LED control)  GND  Logic out (switch signal)	trigger signal at the logic connector:  Logic in (external LED control)  GND  Logic out (switch signal)
Weight	1,210 g	1,210 g	1,210 g
Dimensions (W x D x H)	120 x 170 x 43 mm (4.72" x 6.69" x 1.69")	120 x 170 x 43 mm (4.72" x 6.69" x 1.69")	120 x 170 x 43 mm (4.72" x 6.69" x 1.69")
Operating temperature	-10 °C to +50 °C (+14 °F to +122 °F)	-10 °C to +50 °C (+14 °F to +122 °F)	-10 °C to +50 °C (+14 °F to +122 °F)

### DELIVERY INCLUDES

- Tablestand
- Quick guide
- Safety guide



# SpeechLine Wired

## MAT 133, MAT 133-S, MAT 153-S - Tablestand

### DIMENSIONS

**MAT 133**

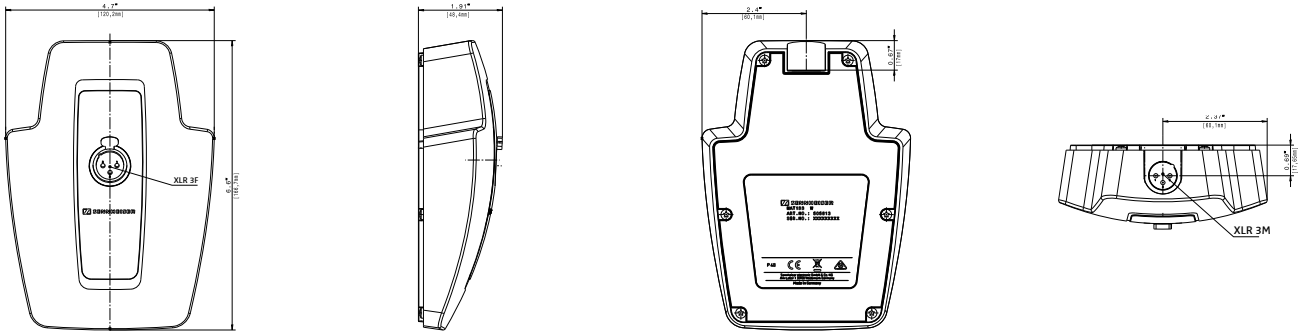

**MAT 133-S**

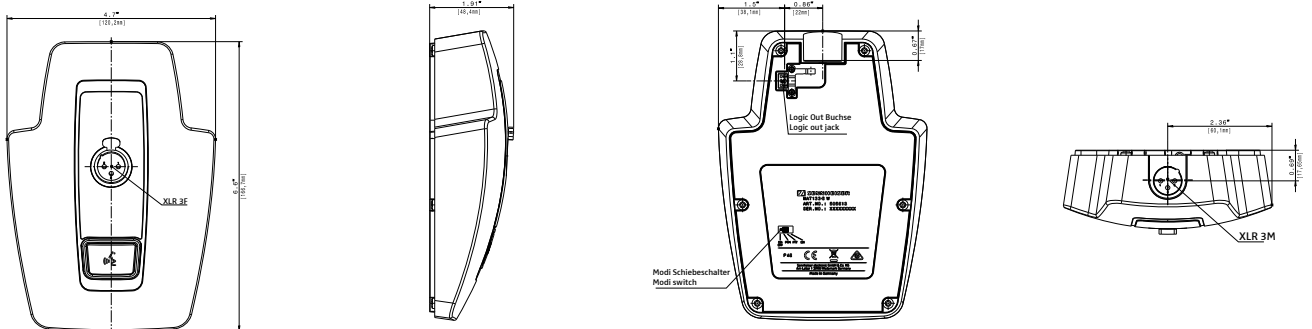

**MAT 153-S**

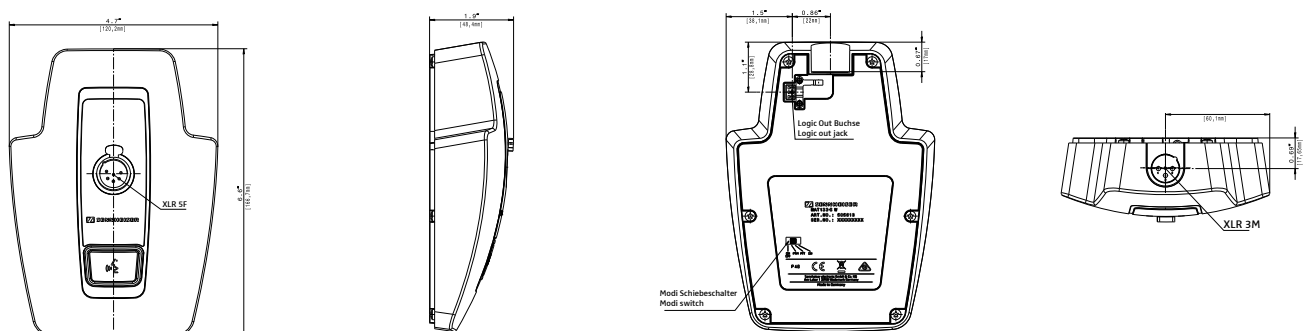

### ACCESSORIES

MEG 14-40 B gooseneck microphone	Art. No. 504791
MZH 3015 gooseneck	Art. No. 005074
MZH 3015-L gooseneck	Art. No. 009435
MZH 3040 gooseneck	Art. No. 005076
MZH 3040-L gooseneck	Art. No. 009436
ME 34 microphone capsule	Art. No. 005060
ME 35 microphone capsule	Art. No. 005063
ME 36 microphone capsule	Art. No. 005065

### PRODUCT VARIANTS

MAT 133 B, black	Art. No. 505622
MAT 133-S B, black	Art. No. 505624
MAT 153-S B, black	Art. No. 505626